



MIDI SOUND MODULE

DIGITAL PIANO

MKS-20

Owner's Manual

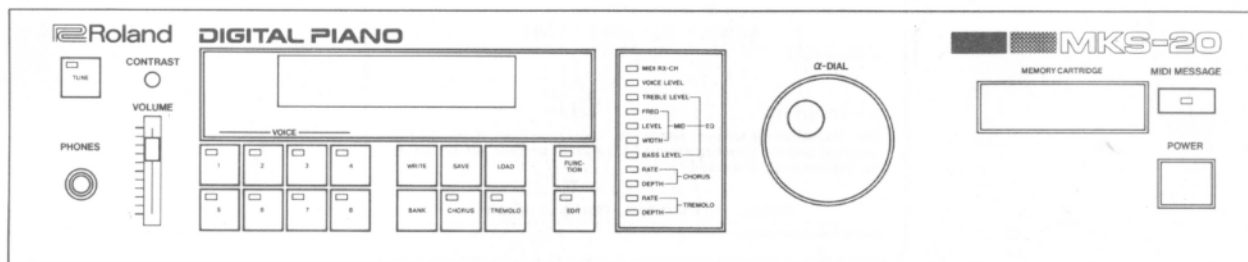

Roland has succeeded in the development of the Structured Adaptive System which is a digital technology that analyzes and extracts the acoustic sound then synthesizes highly expressive sounds.

The Roland Structured Adaptive System makes it possible to analyze and extract the tone color alteration of the acoustic piano sound in each note caused by the difference of the key touch pressure, then reproduces the most natural tone color alteration, according to the note played and its key pressure.

FEATURES

- The Roland MKS-20 MIDI Digital Piano Sound Module features highly expressive sounds owing to its SA sound source.
- The MKS-20 includes the Chorus and the Tremolo effects and an equalizer which serve to make wider variation of tone colors.
- The MKS-20's memory capacity is 8 preset tone colors which cannot be rewritten and 56 which can be programmed to your taste.
- The 64 original tone colors can be saved on the Memory Cartridge (M-16C).
- The back-lighted LCD (Liquid Crystal Display) makes the operation on a dark stage easier.
- The XLR (Balanced type) connectors allow setup with professional equipment.

CONTENTS

1	PANEL DESCRIPTION	3
2	CONNECTIONS	5
3	OPERATION	6
1.	Basic Operation	6
a.	Setting the receive channel	6
b.	Tone Color Selection	7
1)	Tone Color Selection with Buttons on the MKS-20	8
2)	Tone Color Selection with MIDI Program Change	9
c.	Tuning	10
d.	Octave Shift	11
e.	Chorus/Tremolo	11
1)	Chorus	11
2)	Tremolo	11
2.	Editing a Tone Color	12
a.	Calling a Parameter	12
b.	How to Edit	12
c.	Parameters	13
1)	Voice Level	13
2)	Equalizer Section	13
	Treble Equalizer	13
	Treble Level	13
	Middle Equalizer	13
	Frequency	13
	Middle Level	13
	Band Width	13
	Bass Equalizer	14
	Bass Level	14
3)	Chorus	14
	Rate	14
	Depth	14
4)	Tremolo	14
	Rate	14
d.	Memory Cartridge	15
1)	Saving	15
2)	Loading	16
4	MIDI Functions	16
5	Other Functions	17
6	Specifications	23

Please read the separate volume "MIDI", before reading this owner's manual.

Copyright © 1986 by ROLAND CORPORATION

All rights reserved. No part of this publication may be reproduced in any form without the written permission of ROLAND CORPORATION.

1 PANEL DESCRIPTION

<Front Panel>

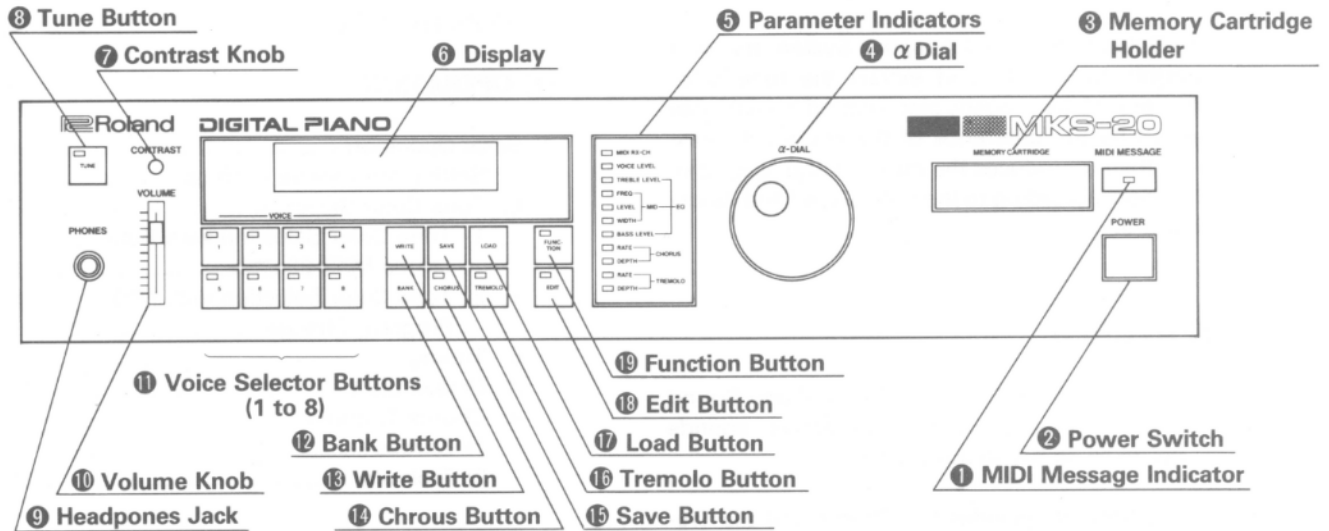

<Rear Panel>

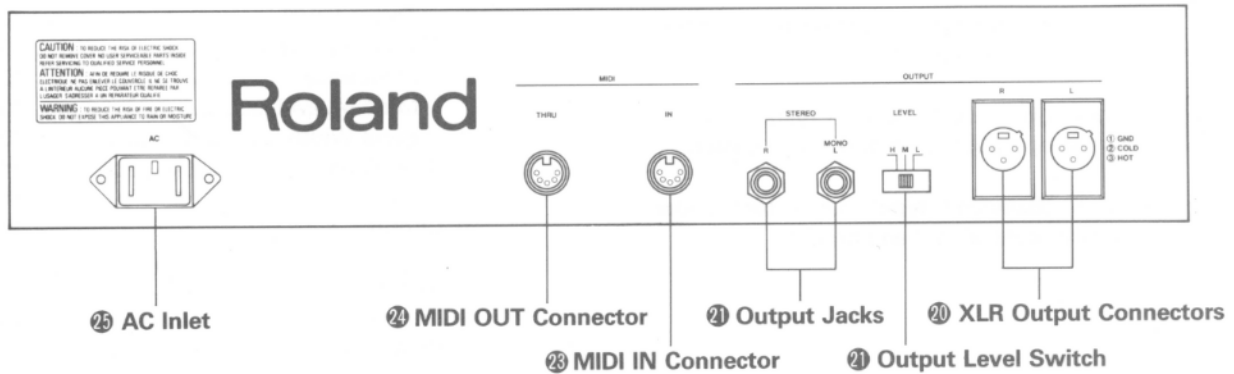

IMPORTANT NOTES

Power Supply

- The appropriate voltage to be used is shown on the name plate on the rear panel. Be sure that it meets the voltage system in your country.
- Do not use the same socket that is used for any noise generating device, such as a motor, or variable lighting system.
- When setting up the MKS-20, be sure that all the units are turned off.
- This unit might not work properly if the power cable is plugged in with the unit turned on. If this happens, simply turn the unit off, and turn it on again in a few seconds.
- This unit might get hot while operating, but there is nothing to worry about it.

Power Cord

When disconnecting the power cord from the socket, do not hold the cord but the plug. When the unit is not to be used for a long period, disconnect the power cord.

Location

- Operating the MKS-20 near a neon or fluorescent lamp may cause noise interference. If so, change the angle or position of the MKS-20.
- Avoid using the MKS-20 in extreme heat or humidity or where it may be affected by dust.

Cleaning

- Use a soft cloth and clean only with a mild detergent.
- Do not use solvents such as paint thinner.

Memory Backup

- The MKS-20's memory back-up system is fully supported by a battery. Normally, the battery replacement is required every five years, but the first replacement may be needed even before that depending how many months had passed before you bought it. Please ask for your local Roland dealer for replacement. Save the data in memory onto a cartridge or make a synthesizer memo of each tone color, before having the MKS-20 repaired. The data may be accidentally lost during repairing process, and if it happens, there is no way to retrieve it.

Bescheinigung des Herstellers / Importeurs

Hiermit wird bescheinigt, daß der/die/das
ROLAND DIGITAL PIANO MODULE MKS-20
(Gerät, Typ, Bezeichnung)

in Übereinstimmung mit den Bestimmungen der
Amtsbl. Vfg 1046 / 1984
(Amtsblattverfügung)

funkentstört ist.
Der Deutschen Bundespost wurde das Inverkehrbringen dieses Gerätes
angezeigt und die Berechtigung zur Überprüfung der Serie auf Einhaltung
der Bestimmungen eingeräumt.

Roland Corporation Osaka / Japan
Name des Herstellers/Importeurs

2 CONNECTIONS

Set up the MKS-20 as shown below.

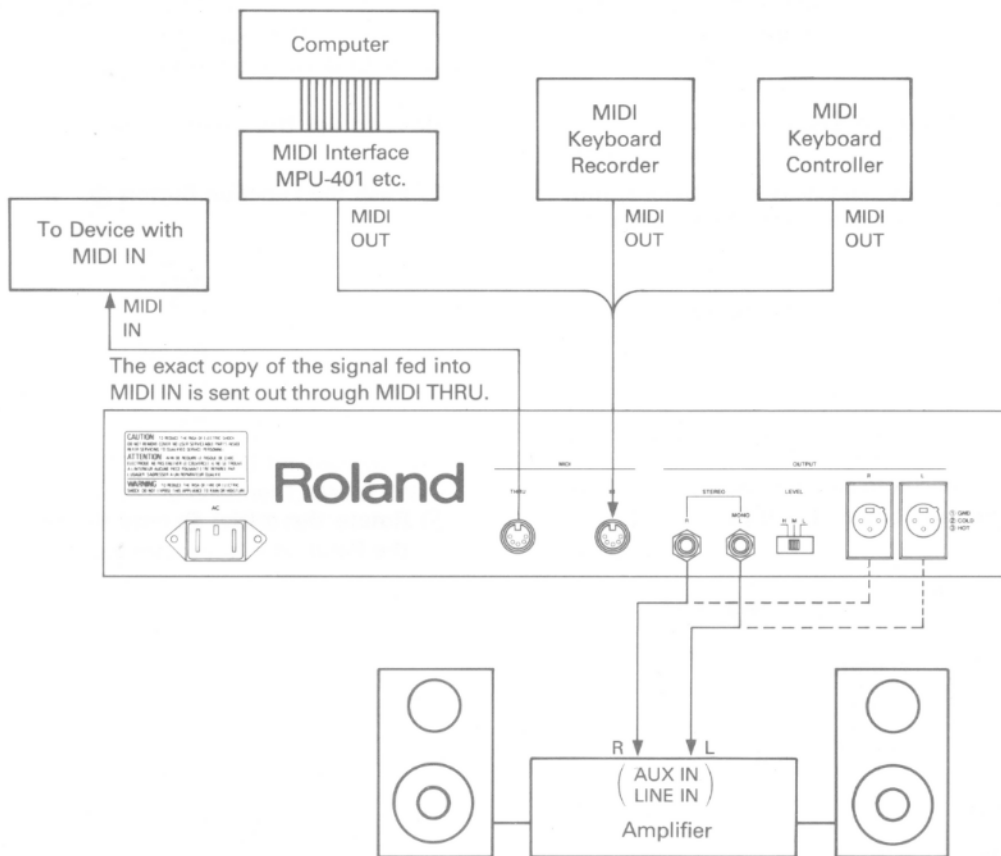

<Output Level Switch>



- Keyboard Amplifier M/H
- Recording Equipment H
- Mixer L/M/H
- Guitar Amplifier L/M
etc.

The Output Level Switch does not work on the balanced output (XLR Output Connectors 19) but on the unbalanced output (Output Jacks 20).

3 OPERATION

The MKS-20 has mainly two modes, Function and Edit. In the Function mode, you can call a tone color or a parameter, and in the Edit mode, the value of the parameter can be edited. To change the modes, use the Function Button 19 and Edit Button 18. The corresponding indicator lights up to tell you which mode is currently selected.

1. Basic Operation

After making all the necessary connections, turn the amplifier's volume to zero, then switch the MKS-20 on.

The Display will react as shown below.

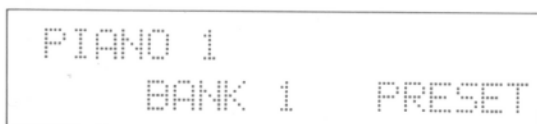

If you find it difficult to see the Display, adjust the contrast with the Contrast Knob 7.

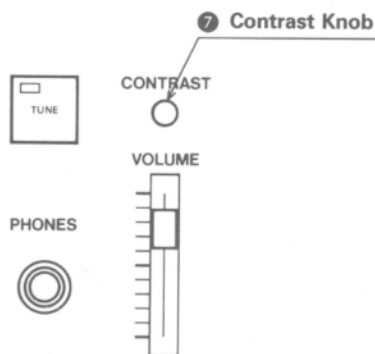

NOTE:

For about two seconds after the MKS-20 is turned on, the muting circuit works.

a. Setting the Receive Channel

It is critical to set the MIDI channel number of the receive unit (MKS-20) and the transmit unit (external MIDI device) to the same number.

How to set the receive channel

- 1 Push the Function Button 19.



- 2 Rotate the α Dial 4 until the MIDI RX-CH of the Parameter Indicators lights up.



The Display responds with:

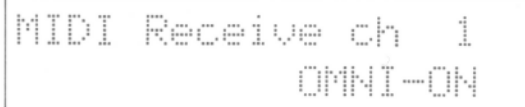

③ Push the Edit button 18.

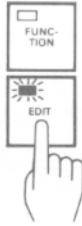

Push the Edit Button, and the Edit Indicator lights up showing the MKS-20 is in the Edit mode.

The Edit Indicator lights up.

Any number of 1 to 16 is valid for receive MIDI channel. When it is set to channel 1, **OMNI ON** or **OFF** can be selected. When **OMNI ON** is selected, the Display will respond with:



While MIDI signal is being received, the MIDI Message Indicator is lighted.

MIDI MESSAGE



b. Tone Color Selection

The MKS-20 retains 64 tone colors: 8 basic voices and other 7 variations for each voice. There are two methods for calling a tone color; by using the Voice Selector Buttons 1 to 8 and the Bank Button, or by sending the MIDI program change message from the external device.

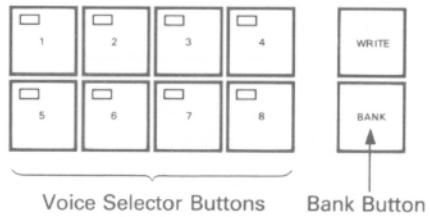

8 different tone colors are preprogrammed in the voices 1 to 8 of Bank 1 as shown below. Each tone color has another 7 variations (Bank 2 to 8). That is, there are altogether 8 variations for one tone color.

- VOICE 1 PIANO 1
- VOICE 2 PIANO 2
- VOICE 3 PIANO 3
- VOICE 4 HARPSICHORD
- VOICE 5 CLAVI
- VOICE 6 VIBRAPHONE
- VOICE 7 E. PIANO 1
- VOICE 8 E. PIANO 2

1) Tone Color Selection with the Voice Selector and the Bank Buttons

To select a basic tone color (Voice), push the appropriate Voice Selector Button.

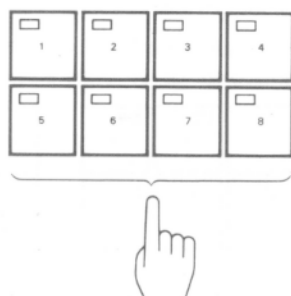

To select other variation of that voice, hold the Bank Button down and push the corresponding Voice Selector Button. Here, the Voice Selector Buttons 1 to 8 correspond to the bank numbers.

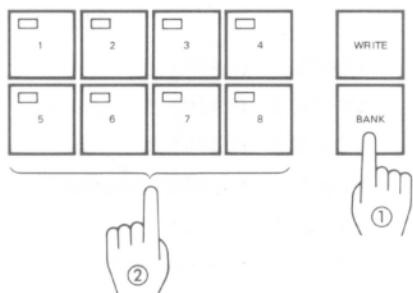

- ① While holding the Bank Button down.
- ② Push a Voice Selector Button (1 to 8) to Select a Bank.

e.g.) Selecting the tone color of Voice 3 (Piano 3) in, Bank 7

- ① Push the Voice Selector Button 3.

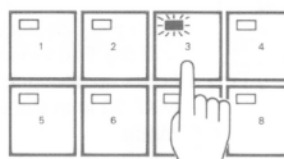

The Display responds with:



- ② While holding the Bank Button down, press the Voice Selector Button 7. This procedure selects the Bank 7.

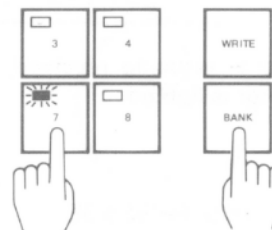

When you select the tone color of the Bank 1 and the tone color is not edited at all, "PRESET" will be shown at the lower right of the Display. If the same tone color is even slightly edited, "PRESET" goes away and does not appear unless the unit is turned off and on again.

The tone colors in **Bank 1** (= basic voices) are non-volatile, that is, it can be edited but the edited tone color is erased when the unit is turned off. On the other hand, any of the tone colors of **Bank 2 to 8** can be edited and retained even after the unit is turned off by battery backup.

2) Tone Color Selection with MIDI Program Change

The MIDI program change messages sent from the external device can change the tone colors on the MKS-20.

The table below shows how the Bank/Voice numbers on the MKS-20 correspond to the program change numbers.

BANK \ VOICE	1	2	3	4	5	6	7	8
BANK 1	1	2	3	4	5	6	7	8
BANK 2	9	10	11	12	13	14	15	16
BANK 3	17	18	19	20	21	22	23	24
BANK 4	25	26	27	28	29	30	31	32
BANK 5	33	34	35	36	37	38	39	40
BANK 6	41	42	43	44	45	46	47	48
BANK 7	49	50	51	52	53	54	55	56
BANK 8	57	58	59	60	61	62	63	64

* The MKS-20 receives the program change numbers 1 to 64 but ignores 65 to 128.

c. Tuning

Procedure

- 1 Push the Tune Button .

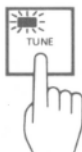

The Tune Indicator lights up showing that the MKS-20 is in the Tune mode.

While in the Tune mode, the Chorus and Tremolo effects are turned off.

- 2 Using the α Dial, tune the MKS-20.

The MKS-20's Tune mode allows the tuning in the range of A = 438 to 446Hz in 0.1Hz step. The value is shown in the Display.

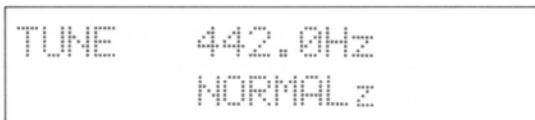

- 3 When the tuning is completed, push the Tune Button.

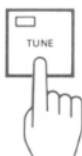

Now the Tune mode is cancelled and the previous Chorus and Tremolo effects set before entering the Tune mode are returned.

d. Octave Shift

The MKS-20 features the Octave Shift function that allows to shift the received Note On/Off messages from -2 to 2 octaves in an octave step.

Procedure

- 1 Push the Tune Button



The Display responds with as shown below.

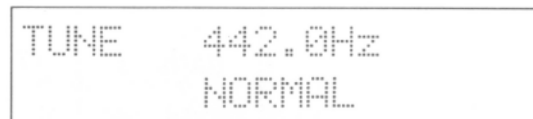

- 2 Push the Voice Selector Button 1.

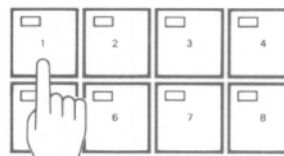

Now, the Display changes to as shown below, and the entire keyboard is shifted one octave up.

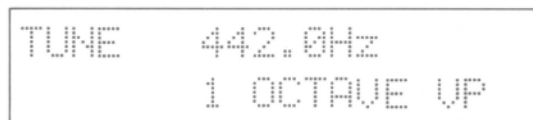

Pushing the Voice Selector Button 1 again here will shift one more octave, that is two octaves up.

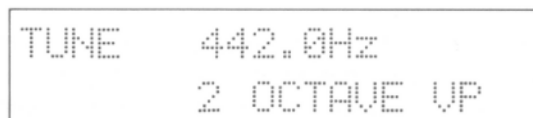

③ Push the Tune Button.

To return to the normal condition, use the Voice Selector Button 5 instead of 1, and the Display will respond with as shown below.

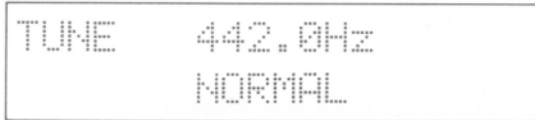

To shift downwards, take the same procedure as ① to ③, but using the Voice Selector Button 5 instead of 1.

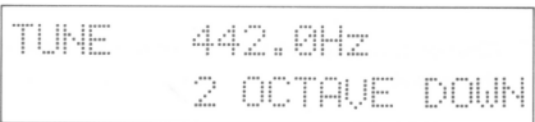
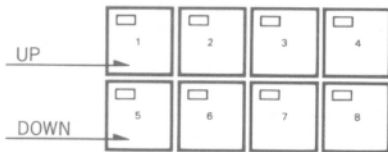
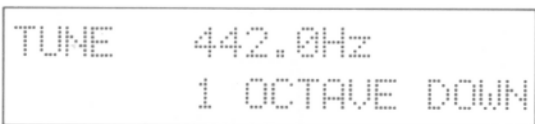

The Octave Shift you have set will be retained even after the MKS-20 is switched off.

e. Chorus/Tremolo

The MKS-20 contains the Chorus and Tremolo effects.

1) Chorus

Push the Chorus Button, and the indicator lights up showing the Chorus effect is turned on.

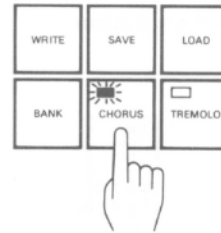

To turn the Chorus effect off, simply push the chorus Button again. The indicator goes out.

2) Tremolo

Push the Tremolo Button, and the indicator lights up showing the Tremolo effect is turned on.

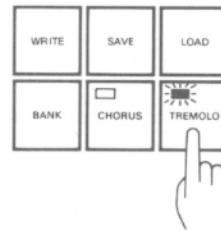

To turn the Tremolo effect off, simply push the Tremolo Button again. The indicator goes out.

2. Editing a Tone Color

All the 64 tone colors in memory can be edited by using the α Dial. The tone colors in Bank 1, however, cannot be rewritten, that is, the edited tone color is erased when the MKS-20 is switched off. The tone colors in Banks 2 to 8 are automatically rewritten by editing operation.

a. Calling a Parameter

- ① Push the Function Button.

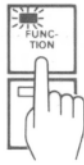

- ② Call the parameter you wish to edit by rotating the α Dial.

Rotating the α Dial will show the Parameter's name and its value in the Display.

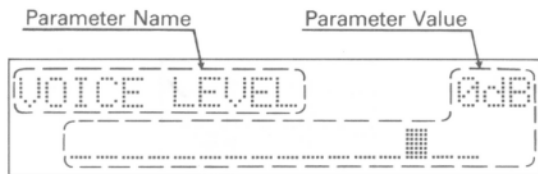

If you wish to return the Display to Bank/Voice indication, simply push any Voice Selector Button or the Bank Button.



Push the Voice Selector Button (1 to 8) or the Bank Button to select a tone color.

b. How to Edit the Parameter

- ① Call the parameter you wish to edit as explained in "a. Calling a Parameter".

- ② Push the Edit Button.

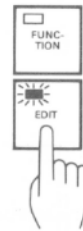

The Edit Indicator lights up showing that the MKS-20 is now in the Edit mode.

- ③ Change the value of the parameter by rotating the α Dial.

c. Parameters

1) Voice Level



16 different voice levels are available for each tone color from -13 to $+2$ dB in 1dB step.

* The level based on (0dB) is that of the tone colors in Bank 1.

2) Equalizer Section

This is the programmable equalizer. Each tone color can individually have its own equalizing.

• Treble Equalizer

This is the shelving type equalizer with 10kHz cutoff frequency.

■ Treble Level



15 different levels are available for boosting or cutting the cutoff frequency from -10.5 dB to $+10.5$ dB in 1.5 steps.

• Middle Equalizer

This is a parametric equalizer that allows to change the center frequency from 400Hz to 4kHz.

■ Frequency



The center frequency of each band is 400Hz, 560Hz, 770Hz, 1kHz, 1.4kHz, 2kHz, 2.8kHz or 4kHz.

■ Middle Level



The frequency selected with the "Frequency" can be boosted or cut in 1.5dB steps from -10.5 to $+10.5$ dB.

■ Band Width (Q)

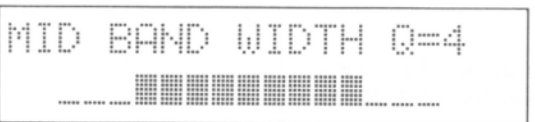

This determines the intensity of the equalizing. 1 to 8 are available, and at 8, the bigger number makes the slope of the boosting or cutting steeper.

● **Bass Equalizer**

This is a shelving type equalizer with the 100Hz cutoff frequency.

■ **Bass Level**



15 levels are available for boosting or cutting the cutoff frequency from -10.5 to $+10.5$ dB in 1.5dB steps.

3) Chorus

The On/Off setting, rate or depth of the Chorus effect can be set.

■ **Rate**



15 levels are available for the rate of the Chorus effect.

■ **Depth**



15 levels are available for the depth of the Chorus effect.

4) Tremolo

The On/Off setting, Rate and Depth of the Tremolo effect can be set.

■ **Rate**



15 levels are available for the rate of the Tremolo effect.

■ **Depth**



15 levels are available for the depth of the Tremolo effect.

To set the tone colors in all the Banks 1 to 8 to the tone colors of the Bank 1, turn the MKS-20 on while holding the Bank Button down.

d. Memory Cartridge

Using the Memory Cartridge (M-16C), the edited data of all the banks (1 to 8) on the MKS-20 can be saved.

The saved data can be loaded back to the MKS-20 at any time.

1) Saving

- ① Make sure the Protect Switch on the Memory Cartridge is set to the ON position.
- ② Securely connect the Memory Cartridge to the Memory Cartridge Holder ③ on the front panel with the Protect Switch side facing upward.

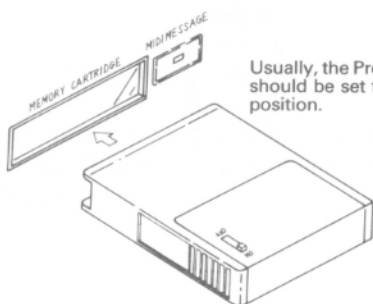

Usually, the Protect Switch should be set to the ON position.

- ③ Set the Protect Switch on the Memory Cartridge to the OFF position.

Now, the Memory Cartridge is ready to accept the data from the MKS-20's memory.

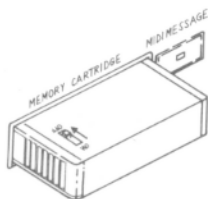

Set the Protect Switch on the Memory Cartridge to the OFF position.

- ④ While holding the Save Button ⑮ down, push the Write Button ⑫.

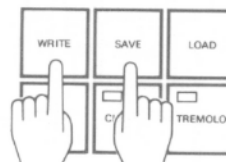

When the saving is completed, the Display responds with:

SAVE COMPLETE

- ⑤ Return the Memory Protect Switch on the Memory Cartridge to the ON position.

If the Memory Protect Switch has not been set to the OFF position, the Display will react as shown below and the saving cannot be done.

MEMORY PROTECTED

If this happens, set the Protect Switch on the Memory Cartridge to the OFF position, then repeat the saving procedure.

2) Loading

- ① Securely connect the Memory Cartridge to the Memory Cartridge Holder ③ on the front panel with the Protect Switch side facing upward.

* The loading procedure should be done with the Protect Switch on the Memory Cartridge set to the ON position.

- ② While holding the Load Button ⑱ down, push the Write Button ⑫.

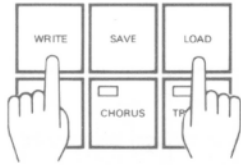

When the loading is completed, the Display responds with:

LOAD COMPLETE

If you try to save or load without the Memory Cartridge connected, the Display will react as shown below.

INSERT CARTRIDGE

NOTE:

When connecting or disconnecting the Memory Cartridge, be sure that its Protect Switch is set to the ON position. If not, the data saved on the Memory Cartridge might be erased.

4 MIDI Functions

The MKS-20 receives the Program Change and Chorus/Tremolo ON/OFF messages. It, however, is possible to set the MKS-20 to the mode of ignoring these messages.

PROCEDURE

While hold the Voice Selector Button 1 down, switch the MKS-20 on.

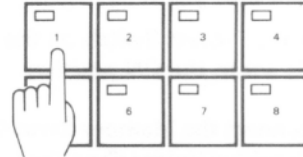

↓
POWER



5 Other Functions

Voice Preserve

The MKS-20 features the Voice Preserve function, that is, while you are playing the keyboard using a certain tone color, you can assign the next tone color to be used, without changing the tone colors until you release all the keys.

When a Program Change message is sent to the MKS-20 with the Note or Damper ON, the tone color does not change. (The indicator of the corresponding tone color flashes.) To change the tone colors, turn all Notes and the Damper OFF. (Now, the indicator of the new tone color is lighted.)

NOTE:

This Voice Preserve function is not available on the tone color selection using the Voice Selector Buttons.

e.g.) Changing from Piano 1 to Clavi

- 1 With Note and Damper ON, send the Program Change 5 (bank-1/Clavi) from the external MIDI device.

The indicator of the voice 5 flashes. The Piano 1 still remains.



- 2 When you wish to change to Clavi, release all the keys and turn the Damper ON.

The indicator of the voice 5 stops flashing and lights steadily.



The Voice Preserve function can be turned on or off by taking the following procedure.

When the Voice Preserve function is off, the tone colors change the moment the Program change is received.

Procedure

To turn the Voice Preserve On:

Switch the MKS-20 on while holding the Voice Selector Button 2 down.

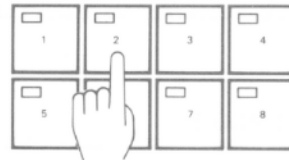

To turn the Voice Preserve Off:

Switch the MKS-20 on while holding the Voice Selector Button 3.

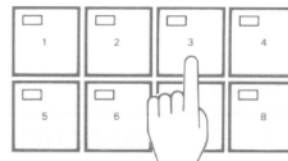

<<Sound Samples>>

● VOICE 1 : PIANO 1

BANK NO.	VOICE	EQUALIZER					EFFECT						MEMO
		BASS	MIDDLE		TREBLE	CHORUS			TREMOLO				
		LEVEL	FREQ	LEVEL	Q	LEVEL	RATE	DEPTH	ON/OFF	RATE	DEPTH	ON/OFF	
1	0	0	1000	0	1	0	3	10	OFF	10	3	OFF	
2	0	0	1000	0	1	0	1	2	ON	8	8	OFF	
3	0	0	1000	0	1	0	1	8	ON	2	3	ON	
4	0	-1.5	2000	+4.5	3	7.5	6	5	OFF	8	8	OFF	
5	2	0	770	-6.0	1	-10.5	4	8	OFF	8	8	OFF	
6	-4	0	770	+10.5	1	0	4	8	OFF	8	8	OFF	
7	0	0	1000	-7.5	4	+4.5	3	3	OFF	4	4	OFF	
8	0	0	2800	+3.0	4	+3.0	1	1	ON	8	8	OFF	

● VOICE 2 : PIANO 2

BANK NO.	VOICE	EQUALIZER					EFFECT						MEMO
		BASS	MIDDLE		TREBLE	CHORUS			TREMOLO				
		LEVEL	FREQ	LEVEL	Q	LEVEL	RATE	DEPTH	ON/OFF	RATE	DEPTH	ON/OFF	
1	0	0	1000	0	1	0	3	10	OFF	10	3	OFF	
2	0	0	1000	0	1	0	1	2	ON	8	8	OFF	
3	0	0	1000	0	1	0	1	8	ON	2	3	ON	
4	0	-1.5	2000	+4.5	3	+7.5	6	5	OFF	8	8	OFF	
5	2	0	560	-3.0	1	-10.5	4	8	OFF	8	8	OFF	
6	2	0	1000	+9.0	1	0	4	8	OFF	8	8	OFF	
7	0	+3.0	1000	-10.5	5	+6.0	3	3	OFF	4	4	OFF	
8	0	0	400	-1.5	1	+1.5	1	1	ON	8	8	OFF	

● VOICE 3 : PIANO 3

BANK NO.	VOICE	EQUALIZER					EFFECT						MEMO
		BASS	MIDDLE		TREBLE	CHORUS			TREMOLO				
		LEVEL	FREQ	LEVEL	Q	LEVEL	RATE	DEPTH	ON/OFF	RATE	DEPTH	ON/OFF	
1	0	0	1000	0	1	0	3	10	OFF	10	3	OFF	
2	0	0	1000	0	1	0	1	2	ON	8	8	OFF	
3	0	0	1000	0	1	0	1	1	ON	10	5	ON	
4	-3	+1.5	2800	+10.5	1	+10.5	6	5	OFF	8	8	OFF	
5	0	0	1000	0	1	-10.5	4	8	OFF	8	8	OFF	
6	0	0	1400	+7.5	1	0	8	8	OFF	8	8	OFF	
7	2	0	770	-7.5	3	+9.0	3	3	OFF	4	4	OFF	
8	0	0	2800	+4.5	5	0	8	8	OFF	8	8	OFF	

● VOICE 4 : HARPSICHORD

BANK NO.	VOICE	EQUALIZER					EFFECT						MEMO
		BASS	MIDDLE		TREBLE	CHORUS			TREMOLO				
		LEVEL	FREQ	LEVEL	Q	LEVEL	RATE	DEPTH	ON/OFF	RATE	DEPTH	ON/OFF	
1	0	0	1000	0	1	0	3	10	OFF	10	3	OFF	
2	0	0	1000	0	1	0	1	3	ON	8	8	OFF	
3	0	0	1000	0	1	0	1	1	ON	10	3	ON	
4	2	-3.0	4000	+3.0	1	+6.0	5	6	OFF	8	8	OFF	
5	2	+1.5	4000	-6.0	1	-10.5	4	12	OFF	8	8	OFF	
6	0	0	1400	+9.0	1	0	8	8	OFF	8	8	OFF	
7	2	+3.0	1400	-10.5	4	0	1	15	OFF	8	2	OFF	
8	0	-6.0	560	+4.5	6	0	8	8	OFF	8	8	OFF	

● VOICE 5 : CLAVI

BANK NO.	VOICE	EQUALIZER					EFFECT						MEMO
		BASS	MIDDLE		TREBLE	CHORUS			TREMOLO				
		LEVEL	FREQ	LEVEL	Q	LEVEL	RATE	DEPTH	ON/OFF	RATE	DEPTH	ON/OFF	
1	0	0	1000	0	1	0	3	10	OFF	10	3	OFF	
2	0	0	1000	0	1	0	3	3	ON	8	8	OFF	
3	0	0	1000	0	1	0	1	1	ON	10	5	ON	
4	0	-6.0	4000	+6.0	1	+10.5	8	8	OFF	8	8	OFF	
5	2	0	2800	-6.0	1	-10.5	4	4	OFF	8	8	OFF	
6	0	0	770	+10.5	1	0	8	8	OFF	8	8	OFF	
7	2	+4.5	1000	-6.0	1	+4.5	1	13	OFF	8	4	OFF	
8	0	0	2000	+10.5	3	+6.0	1	8	ON	8	8	OFF	

● VOICE 6 : VIBRAPHONE

BANK NO.	VOICE	EQUALIZER					EFFECT						MEMO
		BASS	MIDDLE		TREBLE	CHORUS			TREMOLO				
		LEVEL	FREQ	LEVEL	Q	LEVEL	RATE	DEPTH	ON/OFF	RATE	DEPTH	ON/OFF	
1	0	0	1000	0	1	0	3	10	OFF	9	4	OFF	
2	0	0	1000	0	1	0	3	4	ON	8	8	OFF	
3	0	0	1000	0	1	0	8	8	ON	8	8	ON	
4	-3	0	2000	+7.5	1	+6.0	8	8	OFF	8	8	OFF	
5	2	0	2800	-6.0	1	-10.5	8	8	OFF	8	8	OFF	
6	0	0	560	+10.5	1	0	8	8	OFF	8	8	OFF	
7	1	+3.0	2000	-10.5	3	+6.0	8	8	OFF	8	8	OFF	
8	0	0	1000	0	1	0	7	8	ON	8	4	ON	

● VOICE 7 : E. PIANO 1

BANK NO.	VOICE	EQUALIZER					EFFECT						MEMO
		BASS	MIDDLE			TREBLE	CHORUS			TREMOLO			
		LEVEL	LEVEL	FREQ	LEVEL	Q	LEVEL	RATE	DEPTH	ON/OFF	RATE	DEPTH	
1	0	0	1000	0	1	0	3	10	OFF	2	14	OFF	
2	0	0	1000	0	1	0	3	4	ON	8	8	OFF	
3	0	0	1000	0	1	0	8	4	ON	8	4	ON	
4	-2	+3.0	2800	+10.5	1	+7.5	8	8	OFF	8	8	OFF	
5	+2	-7.5	4000	-10.5	1	-10.5	4	12	OFF	4	12	OFF	
6	0	0	770	+10.5	1	0	8	8	OFF	3	8	OFF	
7	+2	-3.0	1000	-10.5	4	+6.0	4	12	OFF	6	4	OFF	
8	0	-4.5	2800	+4.5	4	+6.0	2	14	ON	2	14	ON	

● VOICE 8 : E. PIANO 2

BANK NO.	VOICE	EQUALIZER					EFFECT						MEMO
		BASS	MIDDLE			TREBLE	CHORUS			TREMOLO			
		LEVEL	LEVEL	FREQ	LEVEL	Q	LEVEL	RATE	DEPTH	ON/OFF	RATE	DEPTH	
1	0	0	1000	0	1	0	3	10	OFF	2	14	OFF	
2	0	0	1000	0	1	0	3	4	ON	8	8	OFF	
3	0	0	1000	0	1	0	8	4	ON	8	4	ON	
4	0	+4.5	2800	+10.5	1	+7.5	8	8	OFF	8	8	OFF	
5	2	-6.0	4000	-10.5	1	-10.5	4	12	OFF	4	12	OFF	
6	0	0	400	+10.5	1	0	8	8	OFF	3	8	OFF	
7	1	0	2000	-7.5	3	0	4	12	OFF	6	4	OFF	
8	0	-3.0	1000	0	1	0	2	14	ON	2	14	ON	

6 Specifications

MKS-20: SA System Sound Source, 16 Voice Polyphonic, Digital Piano Module

Memory: Preset 8 Tone Colors (Bank 1), User's Area 56 tone colors (Bank 2 to 8)

<Front Panel>

Buttons & Switches

Power
Tune
Voice Selector (1 to 8)
Write
Save
Load
Bank
Chorus
Tremolo
Function
Edit

Controls

Contrast
Volume
 α Dial

Indicators

Tune
Voice (1 to 8)
Function
Edit
Chorus
Tremolo
Parameter
MIDI RX (receive) Channel
Voice Level
Treble Level
Middle: Frequency
Level
Band Width
Bass Level
Chorus: Rate
Depth
Tremolo: Rate
Depth
MIDI Message

Headphones Jack (Stereo)
Memory Cartridge Holder

<Rear Panel>

Output Jacks (L/R)
Output Level Switch
XLR Output Connectors (L/R, Balanced: 600 Ω)
MIDI IN Connector
MIDI THRU Connector
AC Inlet

Dimensions

480(W) \times 400(D) \times 90(H)mm
19"(W) \times 15-3/4"(D) \times 3-9/16"(H)
(19" Standard Rack Mount type)

Weight

8kg/17lb 10oz

Consumption

30W

Accessories

MIDI Cable (1m) \times 1
Connection Cord (LP-25) \times 2
Owner's Manual
MIDI Guide Book "What is MIDI"

OPTIONS

Stereo Headphones: RH-10
Memory Cartridge: M-16C
MIDI Cable: MSC-07, 15, 25, 50, 100

MODEL MKS-20 MIDI Implementation Chart

Function.....		Transmitted	Recognized	Remarks
Basic Channel	Default Changed		1 - 16 1 - 16	memorized
Mode	Default Messages Altered	*****	Mode 1, 3 POLY, OMNI ON/OFF MONO(m ≠ 1)→1, (M=1)→3	memorized
Note Number	True voice	*****	0 - 127 15 - 113	
Velocity	Note ON Note OFF		○ ×	v=1-127
After Touch	Key's Ch's		×	
Pitch Bender			×	
Control Change	4 7 11 64 67 92 93		○ ○ ○ ○ ○ ○ ○	Foot control Volume Expression Damper pedal Soft pedal Tremolo } * Chorus } * * can be ignored by power-up setting
Prog Change	True #	*****	○ (0 - 63) 0 - 63	can be ignored by power-up setting
System Exclusive			×	
System Common	Song Pos Song Sel Tune		×	
System Real Time	Clock Commands		×	
Aux Messages	Local ON/OFF All Notes OFF Active Sense Reset		×	
			○ (123 - 127)	
Notes		Receiver only.		

Mode 1 : OMNI ON, POLY
Mode 3 : OMNI OFF, POLY

Mode 2 : OMNI ON, MONO
Mode 4 : OMNI OFF, MONO

○ : Yes
× : No

MODEL MKS-20 MIDI Implementation

1. RECOGNIZED RECEIVE DATA

Status	Second	Third	Description	
1000 nnnn	0kkk kkkk	0vvv vvvv	Note OFF, velocity ignored	
1001 nnnn	0kkk kkkk	0000 0000	Note OFF kkkkkkk = 0 - 127 (15 - 113)	*1
1001 nnnn	0kkk kkkk	0vvv vvvv	Note ON kkkkkkk = 0 - 127 (15 - 113) vvvvvvv = 1 - 127	*1
1011 nnnn	0000 0100	0vvv vvvv	Foot control vvvvvvv = 0 - 127	*2
1011 nnnn	0000 0111	0vvv vvvv	Volume vvvvvvv = 0 - 127	
1011 nnnn	0000 1011	0vvv vvvv	Expression vvvvvvv = 0 - 127	*3
1011 nnnn	0100 0000	0vvv vvvv	Damper OFF vvvvvvv = 0 - 63 Damper ON vvvvvvv = 64 - 127	
1011 nnnn	0100 0011	0vvv vvvv	Soft OFF vvvvvvv = 0 - 63 Soft ON vvvvvvv = 64 - 127	
1011 nnnn	0101 1100	0vvv vvvv	Tremolo OFF vvvvvvv = 0 - 63 Tremolo ON vvvvvvv = 64 - 127	*4
1011 nnnn	0101 1101	0vvv vvvv	Chorus OFF vvvvvvv = 0 - 63 Chorus ON vvvvvvv = 64 - 127	*4
1100 nnnn	0ppp pppp		Program Change ppppppp = 0 - 63	*5
1011 nnnn	0111 1011	0000 0000	ALL NOTES OFF	*6
1011 nnnn	0111 1100	0000 0000	OMNI OFF	*7
1011 nnnn	0111 1101	0000 0000	OMNI ON	*7
1011 nnnn	0111 1110	0000 mmmm	MONO ON	*7
1011 nnnn	0111 1111	0000 0000	POLY ON	*7
1111 1110			Active Sensing	

*6 When the ALL NOTES OFF is recognized, all the notes which have been turned ON are turned OFF. However, if the damper ON message has been recognized, these ON notes will be not turned OFF until the Damper OFF message is received.

*7 These Mode Messages (2nd byte = 123 - 127) are also recognized as ALL NOTES OFF.

Mode Messages are recognized as follows:

	POLY ON (127)	MONO ON (126)	MONO ON (126)
	mmmm = 1	mmmm < 1	
OMNI OFF (124)	OMNI = OFF	OMNI = OFF	OMNI = ON
	POLY	POLY	POLY
OMNI ON (125)	OMNI = ON	OMNI = ON	OMNI = ON
	POLY	POLY	POLY

* By the panel operation, the receiver's Basic Channel can be set to Channel 1 - 16 and MODE 3 (OMNI OFF, POLY), or Channel 1 and MODE 1 (OMNI ON, POLY). And these settings are memorized.

Notes :

- #1 Note numbers outside of the range 15 - 113 are transposed to the nearest octave inside this range. The transpose function does not affect the recognized NOTE numbers.
- #2 Foot control is regarded as Volume.
- #3 Expression is regarded as Volume.
- #4 If the power has been applied while the VOICE 1 switch being held down, this message is ignored.
- #5 If the power has been applied while the VOICE 1 switch being held down, this message is ignored.

The assignment of received Program Change messages are as follows.

voice	internal bank number							
	1	2	3	4	5	6	7	8
PIANO 1	0	8	16	24	32	40	48	56
PIANO 2	1	9	17	25	33	41	49	57
PIANO 3	2	10	18	26	34	42	50	58
HARPSICHORD	3	11	19	27	35	43	51	59
CLAVI	4	12	20	28	36	44	52	60
VIFRAPHONE	5	13	21	29	37	45	53	61
E.PIANO 1	6	14	22	30	38	46	54	62
E.PIANO 2	7	15	23	31	39	47	55	63

The program change numbers 64 - 127 are ignored.

If the power has been applied while the VOICE 2 switch being held down, Program Change message's transaction mode will be set to as follows, and memorized.

** When the Program Change message is recognized, the VOICE will be not change to the new VOICE until all the notes are turned OFF and Damper is turned OFF.

If the power has been applied while the VOICE 3 switch being held down, Program Change message's transaction mode will be set to as follows, and memorized.

** When the Program Change message is recognized, all the notes which have been turned ON are turned OFF then the VOICE will be change to the new VOICE.